

Article number: 0102123

Description: Retaining ring J150 DIN472
Spring steel

Measures

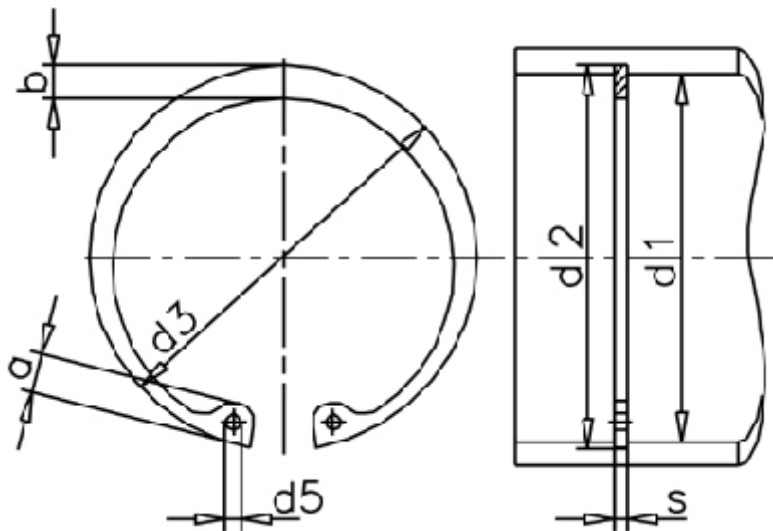

a max	= 12.0	FN kN	= 191.00	t	= 2.00
AN mm ²	= 1198.0	FRg kN	= 64.0	tol	= +0,63
b	= 11.2	FR kN	= 326.0	tol	= +1,50-0,63
d1	= 150	g	= 3.0	tol	= -0.10
d2	= 155.0	K kN-mm	= 748.0	Tong	= ZGJ-4
d3	= 158.00	m min	= 4.15	Weight kg/1000	= 105.00
d5 min	= 4.0	Nominal drive	= 6.0		
Description = J 150		s	= 4.00		